

Data Sheet

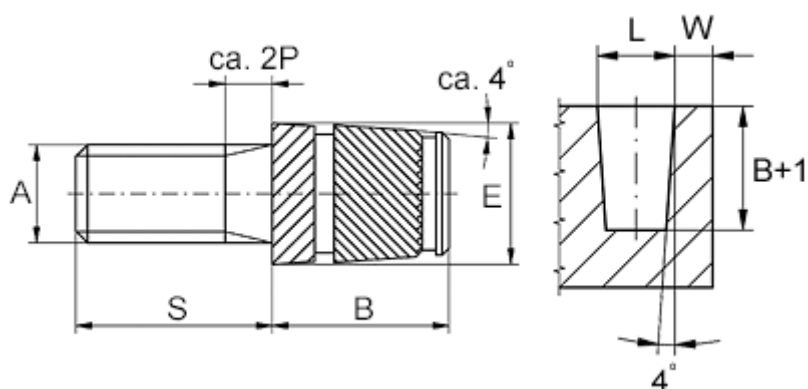

Article number: 12858100080860
Description: KLEE-coil 858 100 080.860
M8 Brass

Measures



Male thread A	= M8x1,25
Min distance to edge W	= 3.0
Mounting length B	= 12.0
Outer diameter E	= 11.2
Pin length S	= 16
Recommended bore diameter W +0.1	= 10.9